

Инструкция по сборке Instructions for assembling furniture Instrukcja montażu mebli

«Серия модульных шкафов»

Корпус шкафа 50/56

Cabinet cupboard 50/56

Korpus szafki 50/56

AH-056.03.00.00

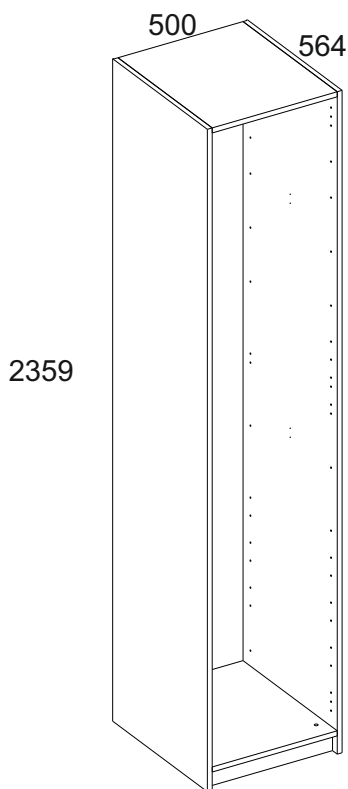

Дата изготовления
Production date
Data produkcji

Штамп ОТК
Stamp of Quality Department
Pieczęć Działu Jakości

ИООО « АНРЭКС »

Республика Беларусь, 224004
г.Брест, ул. Катин Бор, 119
тел/факс (+375162) 30-17-07



ЕАЭС №BY/112 11.01. TP025 018.01 01019
от 01.07.2022
по 30.06.2027

Корпус шкафа 50/56
Korpus szafki 50/56
Cabinet cupboard 50/56

Элементы для докупки
Dodatkowe elementy do zakupu
Additional element for buy

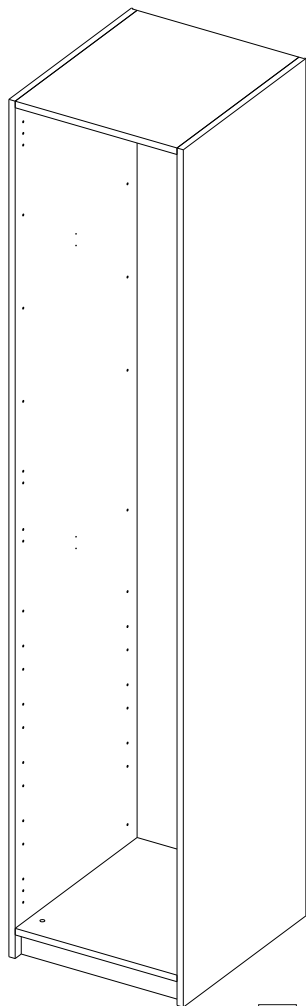

B

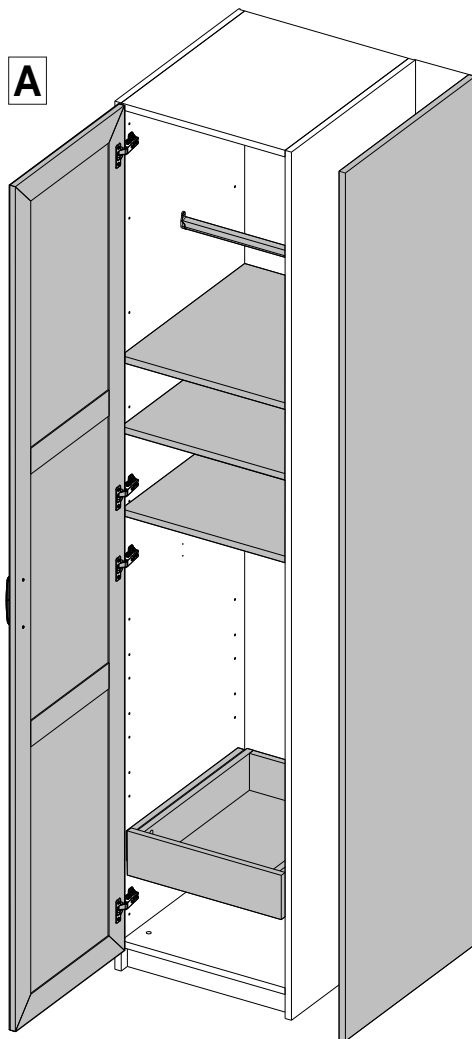

A

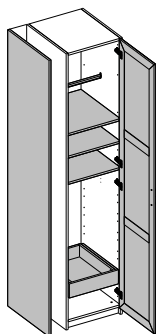

Элементы для докупки
Dodatkowe elementy do zakupu
Additional elements for buying

Комплект полок 50/56
Zestaw półek 50/56 AH-056.11.00.00
Set of shelves 50/56

Ящик 50
Szuflada 50 AH-056.16.00.00
Drawer 50

Дверь 50 Z
Drzwi 50 Z AH-056.19.00.00
Frontage 50 Z

Дверь 50 (F1-1)
Drzwi 50 (F1-1) AH-056.20.00.00
Frontage 50 (F1-1)

Дверь 50 (F1-2)
Drzwi 50 (F1-2) AH-056.21.00.00
Frontage 50 (F1-2)

Накладка 56
Nakładka 56 AH-056.30.00.00
Overlay 56

Штанга 50
Sztanga 50
Crossbar 50

Инструкция по эксплуатации.

Качество и комплектность изделия рекомендуется проверять в магазине при покупке в распакованном виде. Сборка изделия должна производиться в порядке, изложенном в настоящей инструкции. В процессе эксплуатации изделий необходимо периодически затягивать ослабленные винтовые соединения. В случае необходимости перемещения изделия по квартире перед его перестановкой, необходимо полностью освободить его от груза (матраца). Во избежание поломки имеющихся опор передвигать производить приподнимая изделие над уровнем пола. Запрещён прямой контакт с водой. Удаление пыли с изделий следует производить слегка влажной мягкой салфеткой. Во избежание коробления деталей и изменения цвета изделия следует избегать установки мебели на прямых солнечных лучах.

При эксплуатации изделий набора **ЗАПРЕЩАЕТСЯ:**

- устанавливать мебель вблизи отопительных приборов и вплотную к сырým стенам и в помещениях с относительной влажностью более 70%;
- температура нагрева элементов мебели не должна превышать +40 °С.
- в процессе сборки и эксплуатации изделий набора становиться ногами на горизонтальные щиты и витрины;
- применять химические чистящие средства для уборки мебели;

Гарантии изготовителя.

1. Гарантийный срок эксплуатации изделия - 24 месяца со дня продажи магазином. В период гарантийного срока изготовитель гарантирует ремонт изделий или их замену, если потребителем не нарушены правила эксплуатации.
2. Претензии предъявляются потребителем непосредственно в торгующую организацию, в которой была приобретена мебель, предъявив настоящую "Инструкцию по сборке" и копию товарного чека.
3. Изделие **Корпус шкафа 50/56**, входящее в состав **«Серия модульных шкафов»** (мебель универсально-сборная), соответствует требованиям ГОСТ 16371-2014, ТР ТС 025/2012.
4. Срок службы мебели - 5 лет.
5. Предприятие-изготовитель оставляет за собой право вносить изменения в конструкцию изделия, не ухудшая его конструктивные и эксплуатационные характеристики.
6. Для сборки изделий рекомендуется привлекать квалифицированных специалистов.

Запах.

От новой мебели может исходить запах материалов, из которых она изготовлена. Запах может сохраняться в течение трёх недель с момента сборки. Для снижения интенсивности запаха рекомендуется:

-для мягкой мебели - пропылесосить изделие и проветрить помещение.

Повторять 3-4 раза в день.

-для корпусной мебели – протирать тканью, смоченной мягким моющим средством, вытирать чистой сухой тканью и проветривать помещение, предварительно открывая все двери и ящики изделия.

Повторять 3-4 раза в день.

Важно! Сохраните, пожалуйста, инструкцию в случае повторной сборки мебели или рекламации. В случае составления рекламации пользуйтесь, пожалуйста, обозначением из инструкции сборки.

PL

Przy eksploatacji mebli zabrania się:

- ustawiać meble w pobliżu grzewczych przyrządów i obok wilgotnych ścian, a także w pomieszczeniach ze względną wilgotnością więcej niż 70%;
- temperatura nagrzewania elementów mebli nie może przekraczać +40°C;
- w trakcie montażu i eksploatacji mebli stawać nogami na poziome panele i witryny;
- stosować chemiczne środki czyszczące do sprzątania mebli;
- nie należy narażać na kontakt z wodą.

Gwarancje producenta.

1. Gwarancyjny termin eksploatacji wyrobu - 24 miesiące z dnia sprzedaży. W okresie gwarancyjnego terminu producent gwarantuje naprawę wyrobów lub ich zamianę, jeżeli reguły eksploatacji nie zostały naruszone przez nabywcę.
2. Roszczenia są przekazywane przez nabywcę bezpośrednio do handlującej organizacji, w której były nabyte meble, tylko przy okazaniu danej "Instrukcji montażu" wraz z dokumentem zakupu.
3. Wyrób **Korpus szafki 50/56**, wchodzące w zestaw mebli **«Seria modułowych szaf»**, odpowiada wymaganiom Norm Państwowych 16371-2014, TP TC 025/2012.
4. Trwałość użytkowa mebli - 5 lat.
5. Firma-producent pozostawia za sobą prawo do wprowadzania zmian w konstrukcje wyrobów, nie pogarszając ich konstruktywne i eksploatacyjne charakterystyki.
6. Do montażu wyrobów zaleca się skorzystanie z pomocy wykwalifikowanych specjalistów.

Zapach.

Nowe meble mogą wydzielać zapach materiałów, z których są wykonane. Zapach może utrzymywać się do trzech tygodni od momentu montażu. Aby zmniejszyć intensywność zapachu, zaleca się:

- w przypadku mebli tapicerowanych - odkurzyć produkt i przewietrzyć pomieszczenie.

Powtarzaj 3-4 razy dziennie.

- dla mebli szafkowych - przetrzyj ściereczką zwilżoną łagodnym detergentem, przetrzyj czystą, suchą ściereczką i przewietrz pomieszczenie, uprzednio otwierając wszystkie drzwi i szuflady produktu.

Powtarzaj 3-4 razy dziennie.

Ważne! Proszę zachować instrukcję w razie ponownego montażu mebli lub reklamacji. Podczas składania reklamacji prosimy o korzystanie z oznaczeń z instrukcji.

EN

Instruction manual.

It's advised to check the quality and completeness of the product in the store when buying unpacked. Assembling of the product should be done the way it's described in this manual. While the product is in service loose screw connections should be periodically tightened. If it's necessary to move items around the apartment before moving you should release the product completely from the load (the mattress). To prevent damage to existing supports the product should be lifted before moving. Furniture should not be exposed to contact with water. Dusting the product should be done with a slightly damp soft cloth. To prevent warping of parts and discoloration of products do not install furniture in direct sunlight.

While the product is in service it's PROHIBITED TO:

- Install furniture near heating devices, close to the raw walls and in rooms with a relative humidity of more than 70%;
- heat elements of furniture to the temperature higher +40°C;
- step on the horizontal shields and windows during assembly and use of the products set;
- use chemical cleaners for cleaning furniture;

Manufacturer's warranty.

1. The warranty period of use of the product - 24 months from the date of sale. During the warranty period the manufacturer guarantees repair or replacement of products, if the user has not violated operating rules.
2. Claims should be made by the consumer directly to the trading organization, in which furniture was purchased, presenting the "Instruction manual" and a copy of the sales receipt.
3. The product **Cabinet cupboard 50/56**, which is part of a set of **«Series of modular cabinets»**, meet the requirements of GOST 16371-2014, TR TS 025/2012.
4. The lifetime of furniture - 5 years.
5. The manufacturer reserves the right to make changes in product design, without compromising its design and application requirements.
6. To assemble the products it's recommended to attract qualified personnel.

Smell.

New furniture may emit the smell of the materials from which it is made. The smell can persist for up to three weeks from the time of assembly. To reduce odor intensity, it is recommended:

- for upholstered furniture - vacuum the product and ventilate the room.

Repeat 3-4 times a day.

- for cabinet furniture - wipe with a cloth dampened in a mild detergent, wipe with a clean, dry cloth and ventilate the room, previously opening all doors and drawers of the product.

Repeat 3-4 times a day.

It is important! Keep the instruction in case of reassembly of furniture or complaint. When making a claim use the notation from the instruction.

№ п/п	Длина, мм.	Ширина, мм.	Толщина, мм.	Кол-во, шт.	№ пачки
1	464	561	18	1	1/2
2	464	561	18	1	1/2
13	2355	564	18	1	2/2
14	2355	564	18	1	2/2
5	464	65	18	1	1/2
6	2286	490	2,5	1	2/2

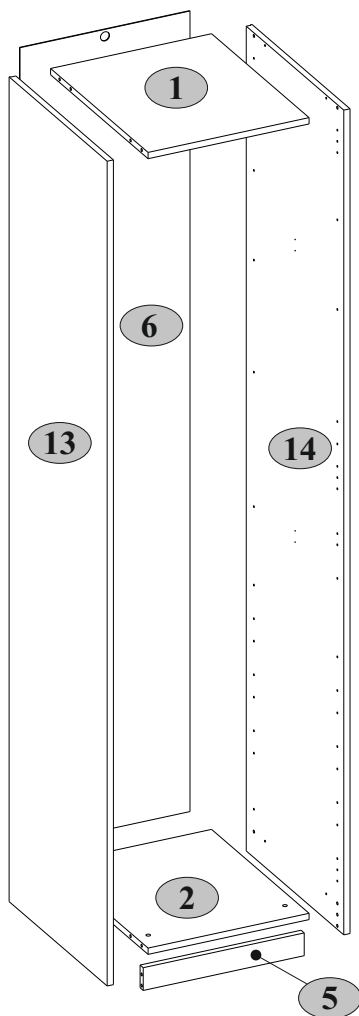
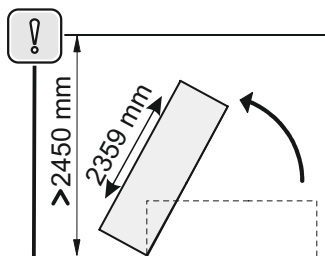
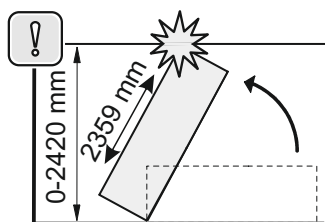



A1 7x34 8	A2 Ø15x12 8	A3 M4x30 4	B5 10x50 1
C1 8x35 12	I S4 1	N1 4	N16 M10 2
N17 L=85 2	R3 3x20 20	R102 3,5x16 2	S5 Ø18 4
S11 Ø8 68	S8-1 Ø20 2	U 90x35x15 1	

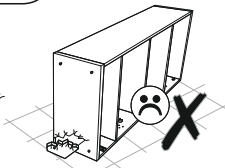
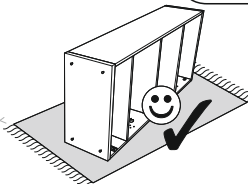
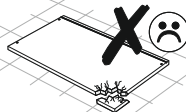
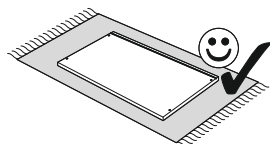
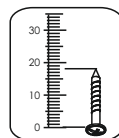
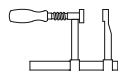
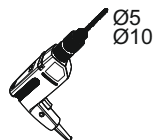
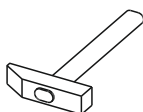
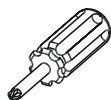
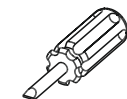
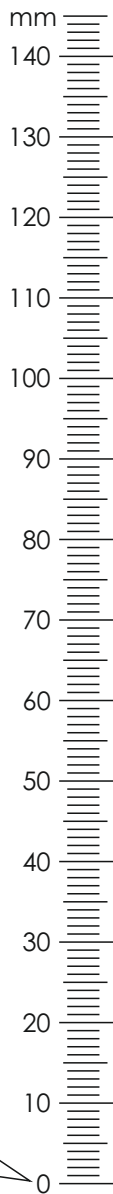

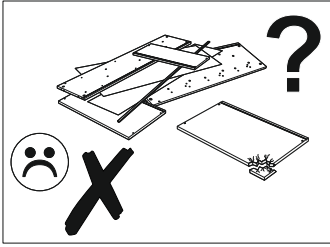

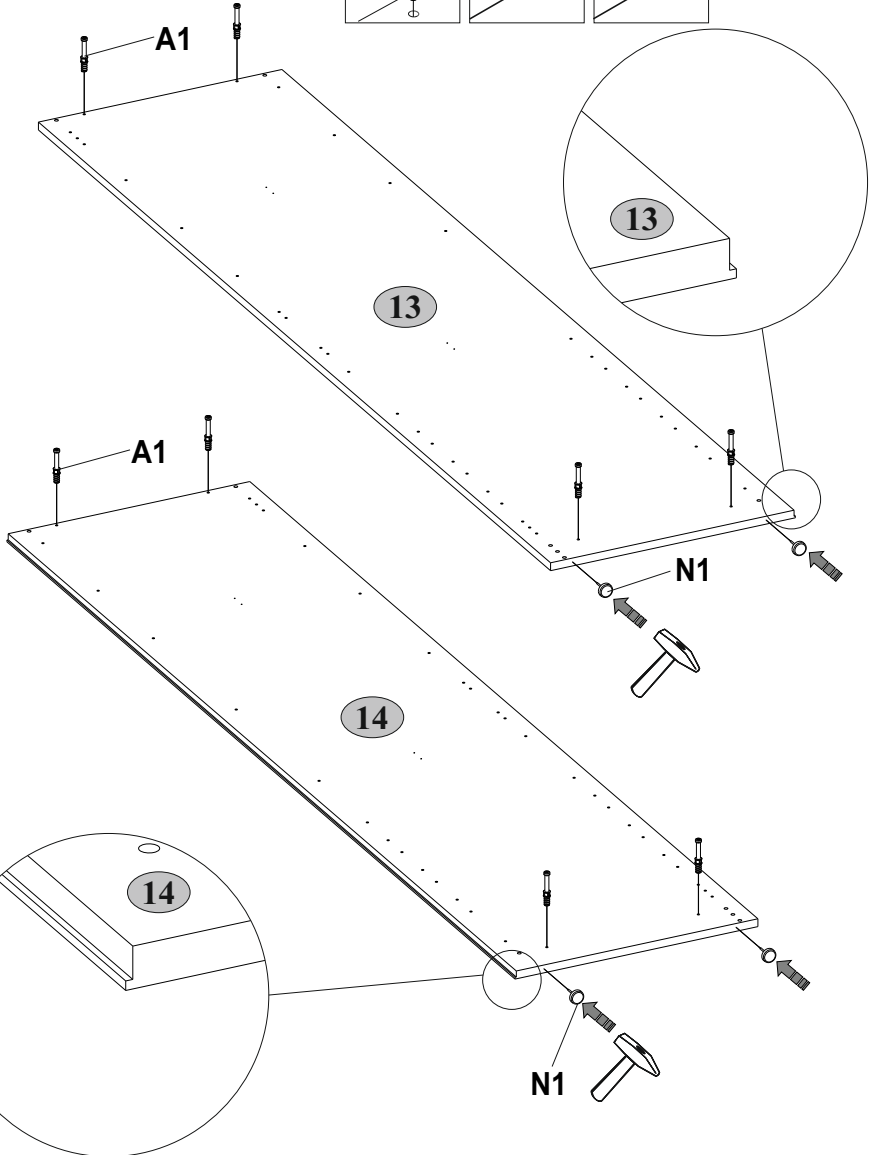
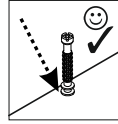
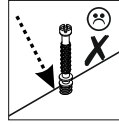
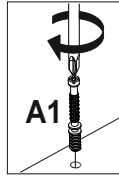
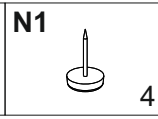
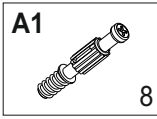

1

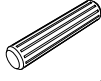

2

A2  Ø15x12 8	C1  8x35 12	N16  M10 2
--	---	--

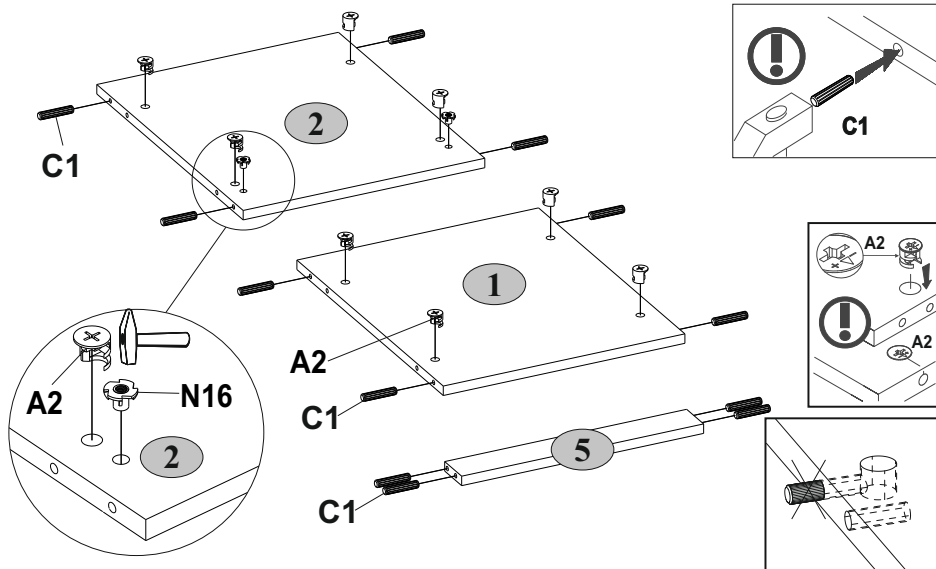
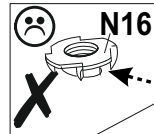
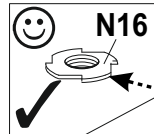

Main assembly diagram for step 2 showing the installation of the top panel (1) and side panel (5) onto the base (2). Components A2, C1, and N16 are used for fastening. A circular inset shows a close-up of the A2 screw and N16 nut being inserted into the panel. A warning icon with an exclamation mark is shown next to a screw being driven into the panel. Another inset shows a warning icon with an exclamation mark and a screw being inserted into the side panel (5).

3

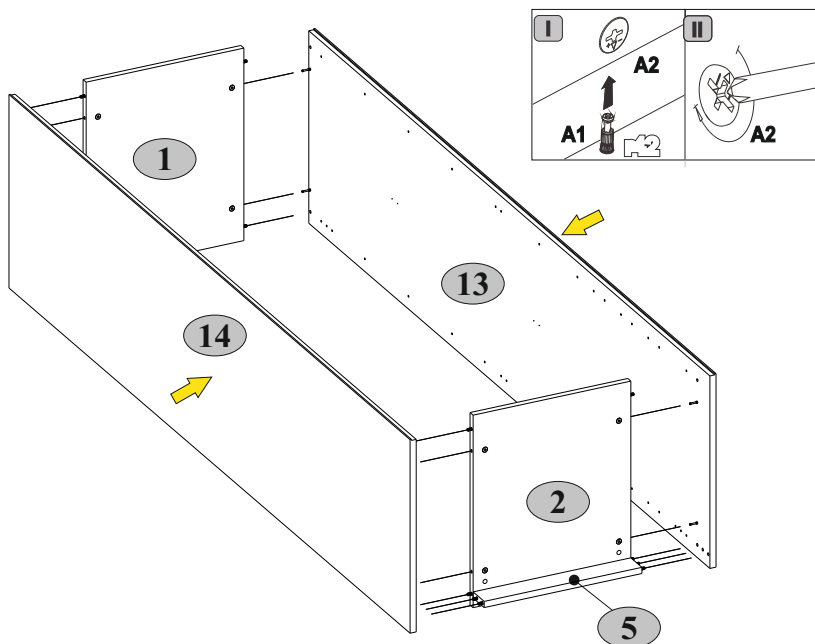

Main assembly diagram for step 3 showing the installation of the front panel (1) and back panel (2) onto the side panels (13 and 14). Component A1 is used for fastening. A circular inset shows a close-up of the A1 screw being inserted into the front panel (1). A warning icon with an exclamation mark is shown next to the A1 screw being inserted into the front panel (1). Another inset shows a warning icon with an exclamation mark and a screw being inserted into the back panel (2).

4

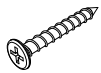
N17	R3
	
L=85	2
2	3x20
	20

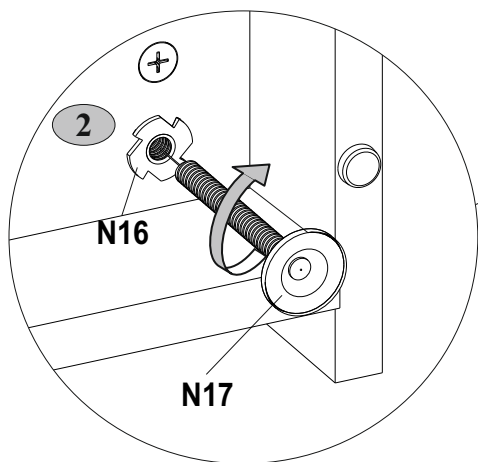
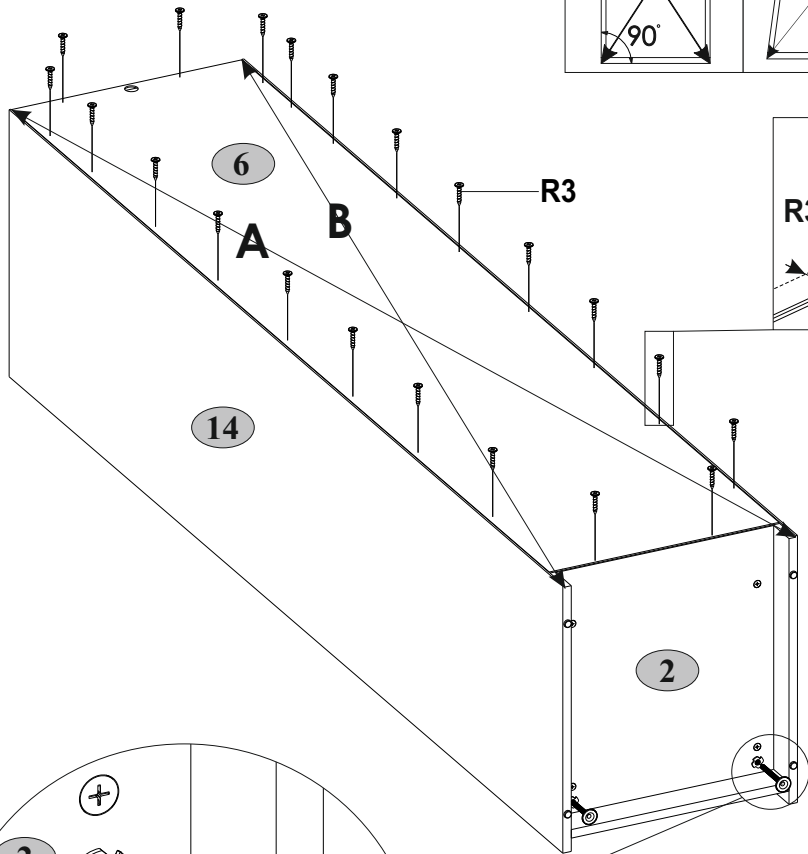
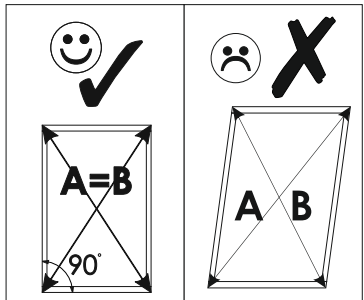
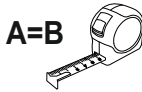

5

B5

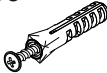

10x50

1

I



S4

1

R102



3,5x16

2

S5



Ø18

4

S8-1



Ø20

2

U



90x35x15

1

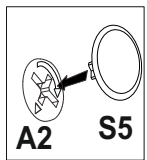
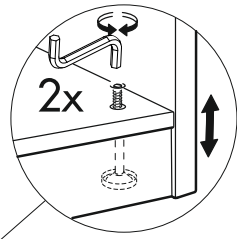
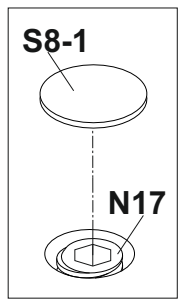
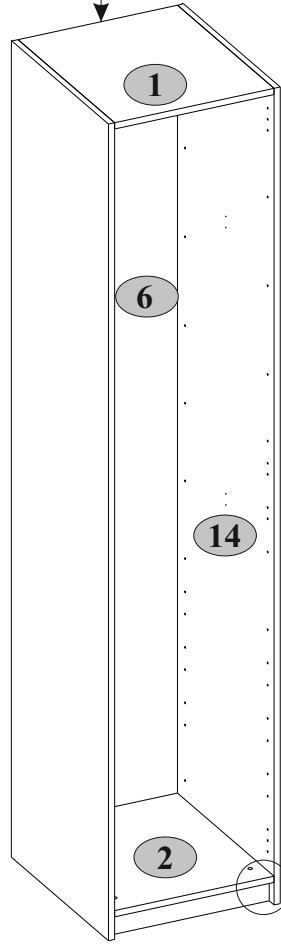
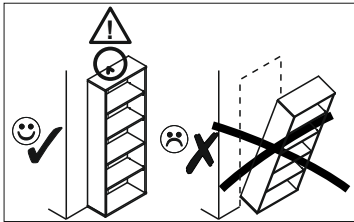
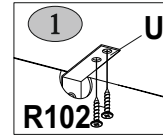
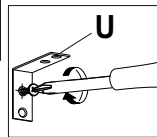
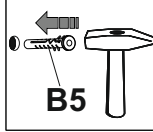
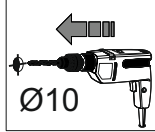
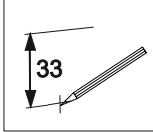
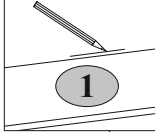

Комплект полок 50/56
 Zestaw półek 50/56
 Set of shelves 50/56

AH-056.11.00.00

№ п/п	Длина мм	Ширина мм	Толщина мм	Кол-во шт.	№ пачки
1	464	561	18	3	1/1

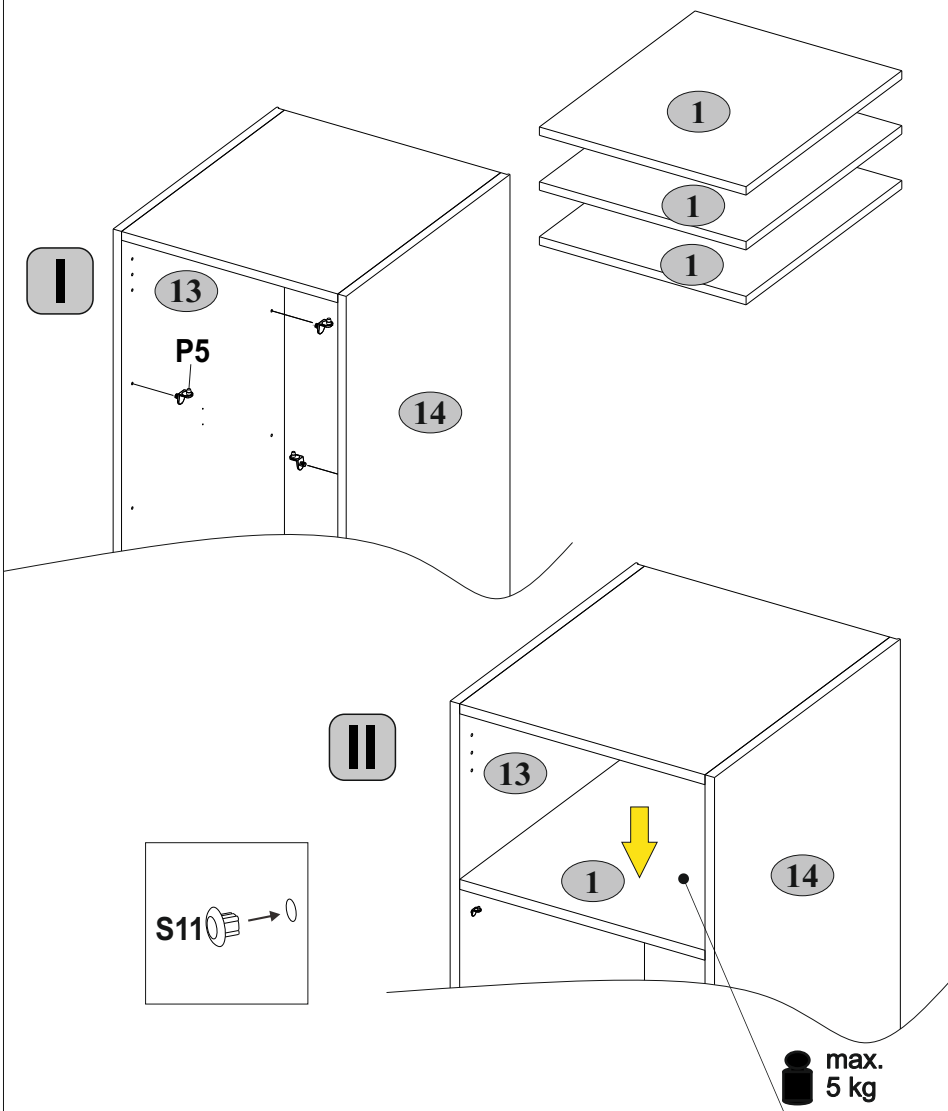
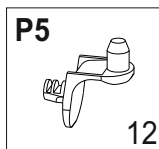







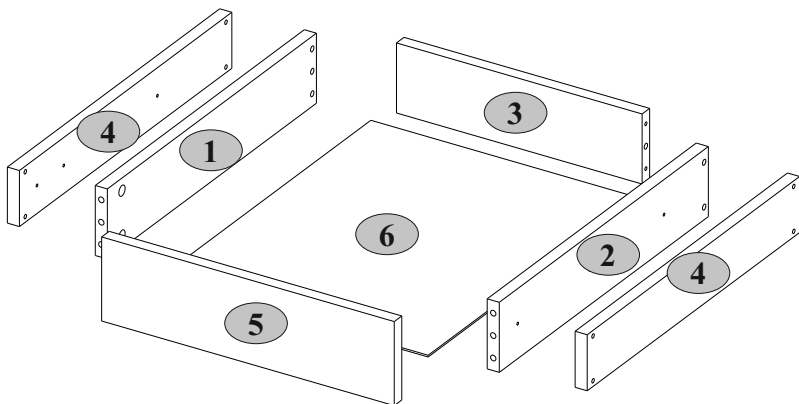



Ящик 50
Szuflada 50
Drawer 50

АН-056.16.00.00

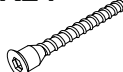
№ п/п	Длина, мм.	Ширина, мм.	Толщина, мм.	Кол-во, шт.	№ пачки
1	500	100	18	1	1/1
2	500	100	18	1	1/1
3	366	100	18	1	1/1
4	508	80	18	2	1/1
5	436	120	18	1	1/1
6	400	505	2,5	1	1/1



A1  7x34 4	A2  Ø15x12 4	C1  8x35 4	I  S4 1	Q  1,5x7 2
R3  3x20 10	R24  7x50 4	R27  5,0x13 12	R43  6,3x30 8	S5  Ø18 4
Z13  450 1				

1**A1**

7x34

A2

4

Ø15x12

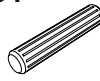
C1

4

8x35

I

4

S4

R24

1

7x50

4

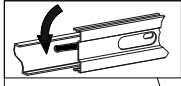
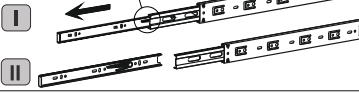
**Z13****R27**

5,0x13

S5

6

Ø18

4

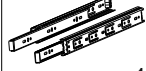
Z13

450

1

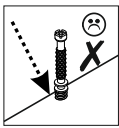
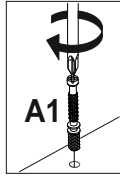
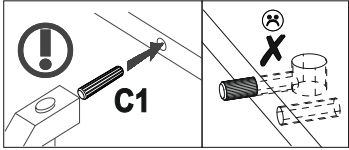
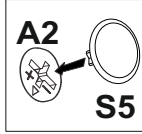
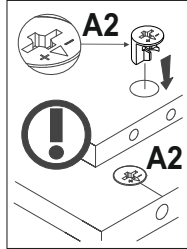
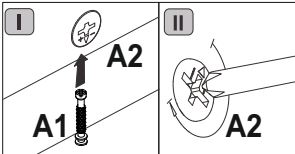
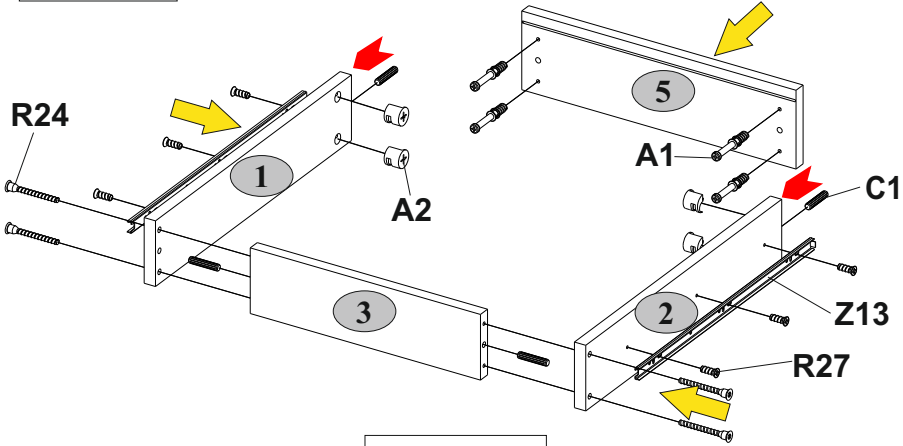
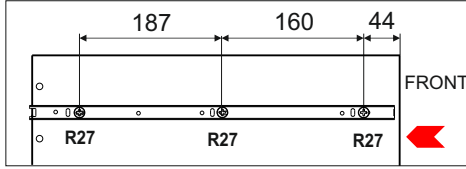
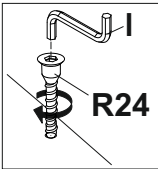

2

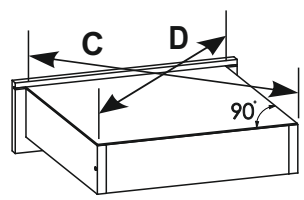
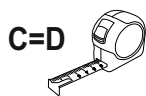
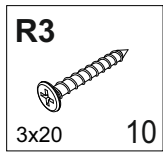

I

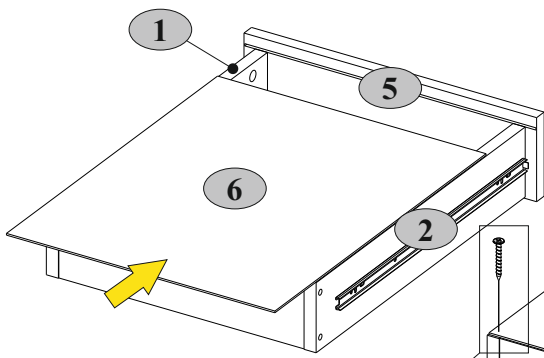

II

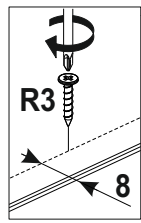
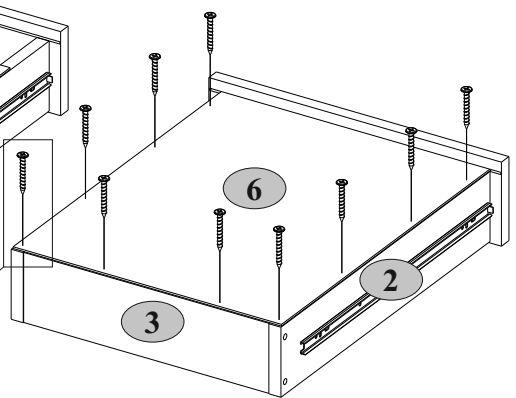

3

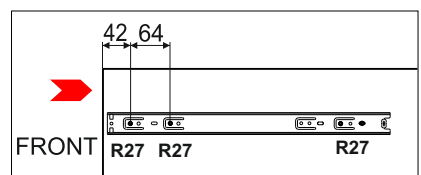
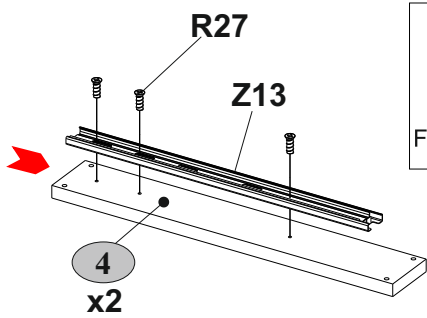
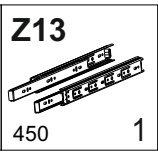
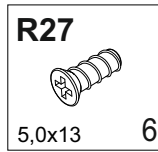

4

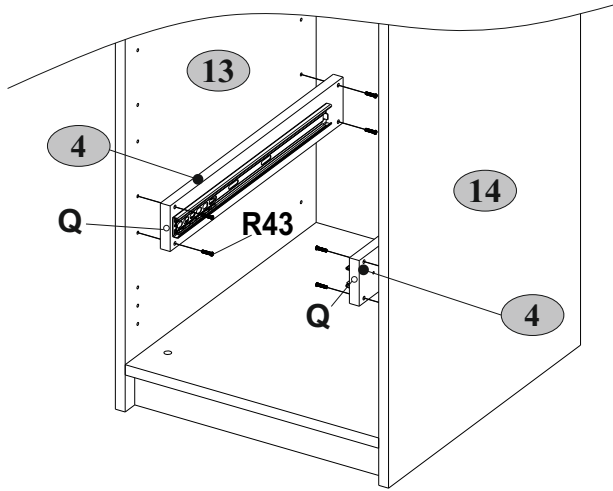
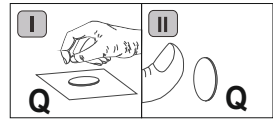
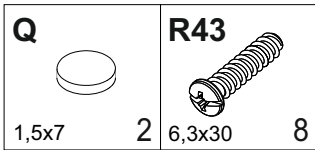

5

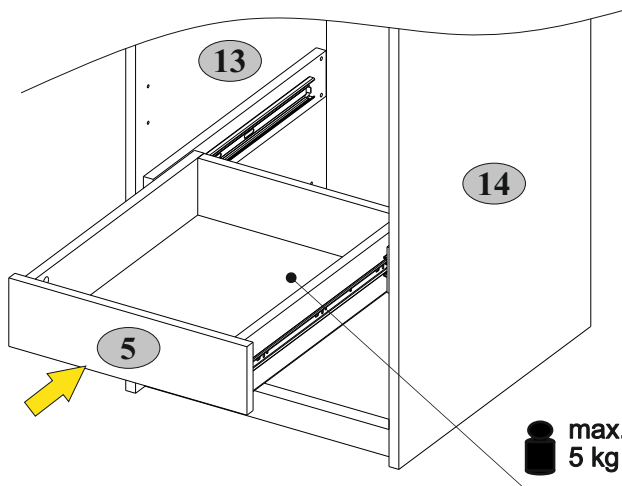

Дверь 50 (F1-1)
 Drzwi 50 (F1-1)
 Frontage 50 (F1-1)

АН-056.20.00.00

Дверь 50 (F1-2)
 Drzwi 50 (F1-2)
 Frontage 50 (F1-2)

АН-056.21.00.00

№ п/п	Длина мм	Ширина мм	Толщина мм	Кол-во шт.	№ пачки
7	2292	496	19	1	1/2



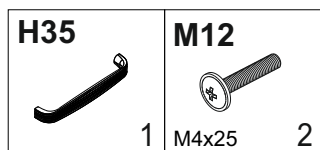

1/2

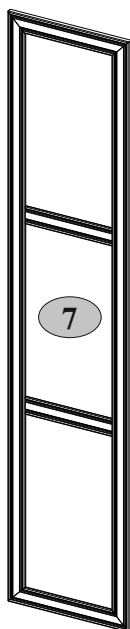
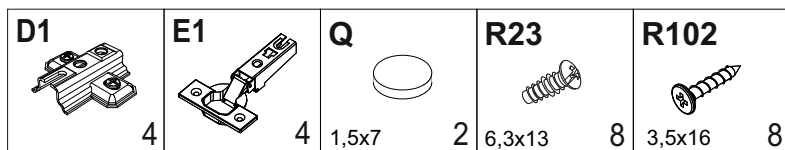

2/2

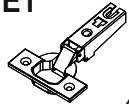

1

E1  4	H35  1	M12  M4x25 2	R102  3,5x16 8
---	--	--	--

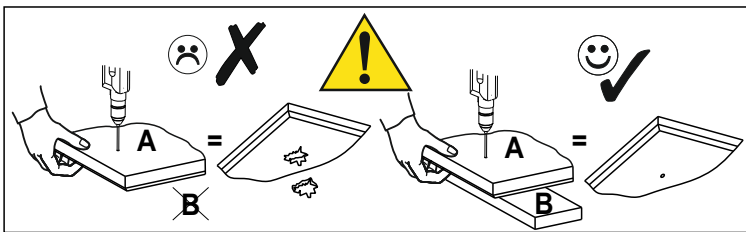
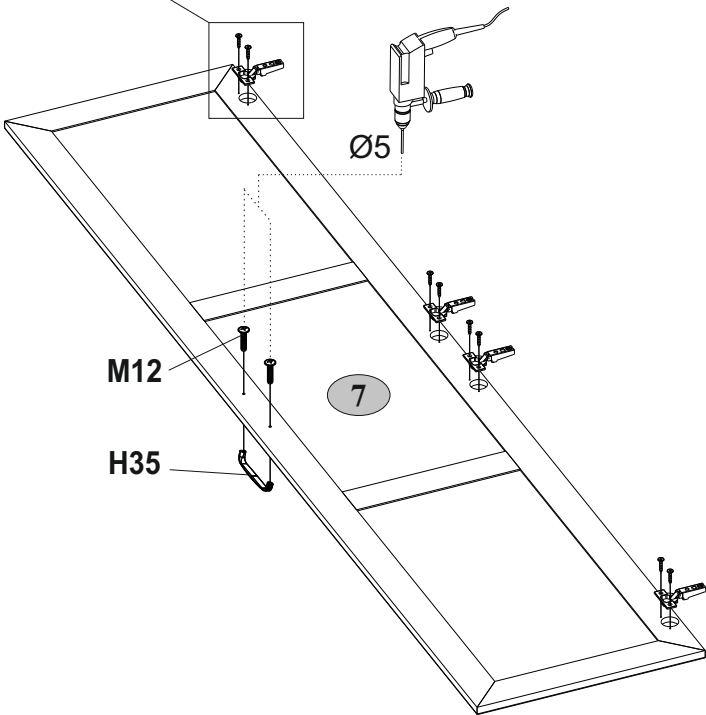
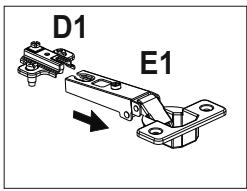
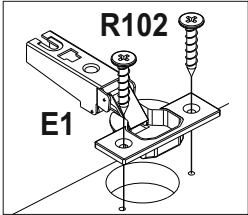



Дверь 50 Z
 Drzwi 50 Z
 Frontage 50 Z





AH-056.19.00.00

№ п/п	Длина мм	Ширина мм	Толщина мм	Кол-во шт.	№ пачки
9	2292	496	22	1	1/2

1/2

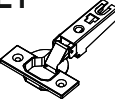

H32 	R102 
1	3,5x16 2

2/2

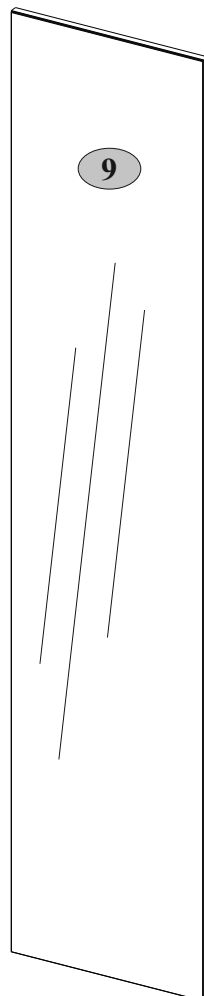
D1 	E1 	Q 
4	4	1,5x7 2
R23 	R102 	
6,3x13 8	3,5x16 8	



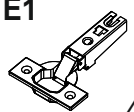

1

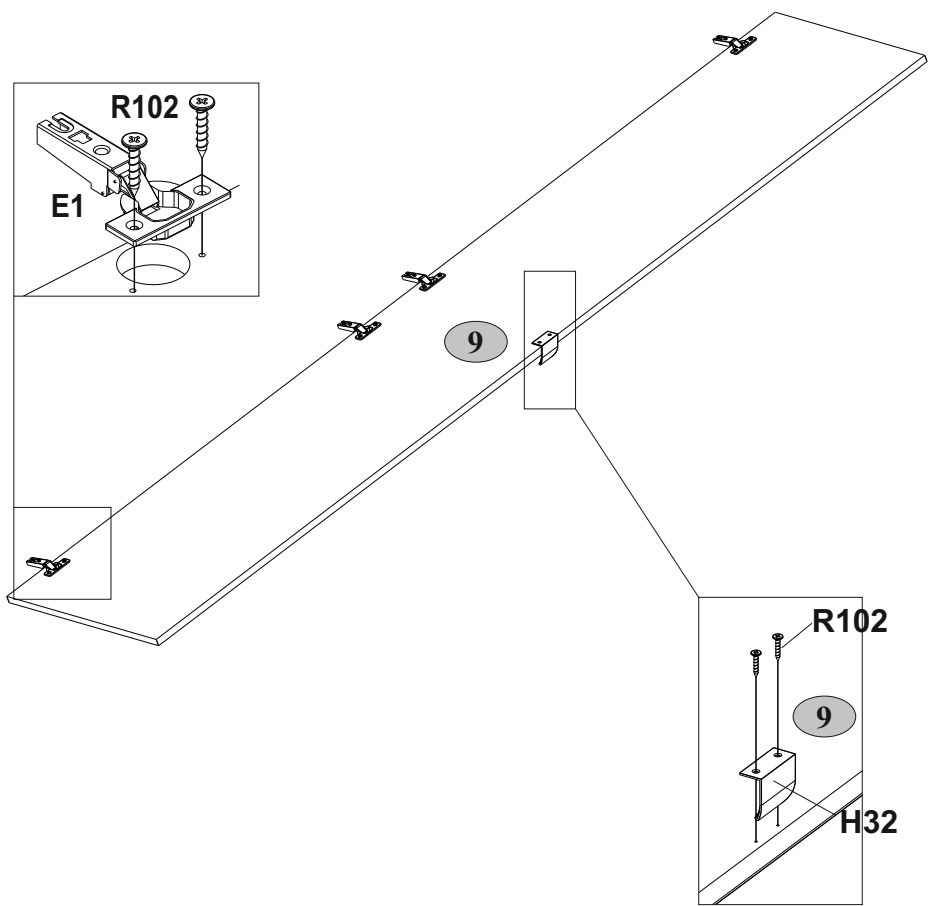
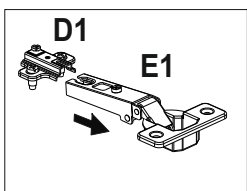
E1  4	H32  1	R102  3,5x16 10
---	--	---

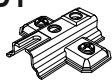

2

D1 	Q 	R23 		
4	1,5x7	2	6,3x13	8

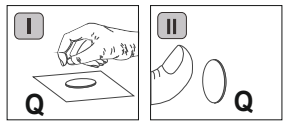

A

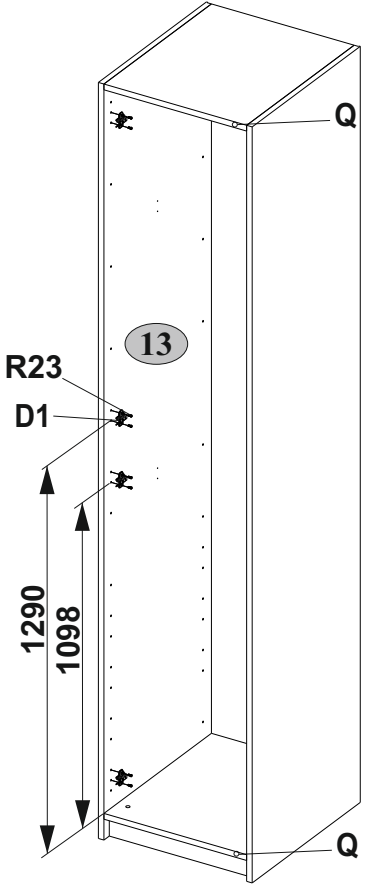

B

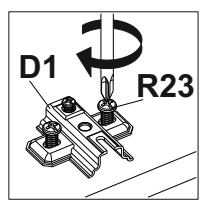
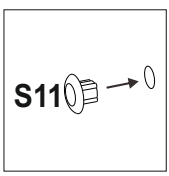
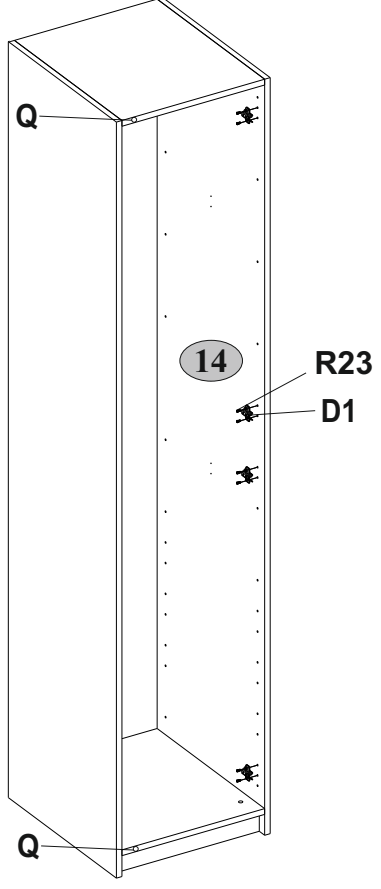

3

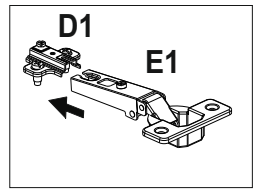
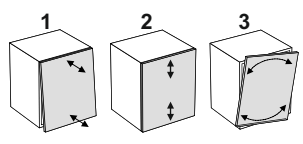
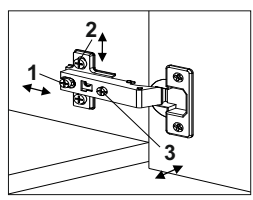
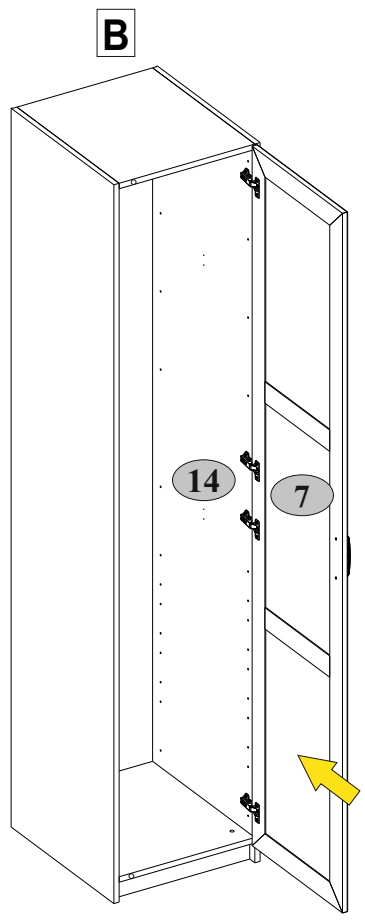
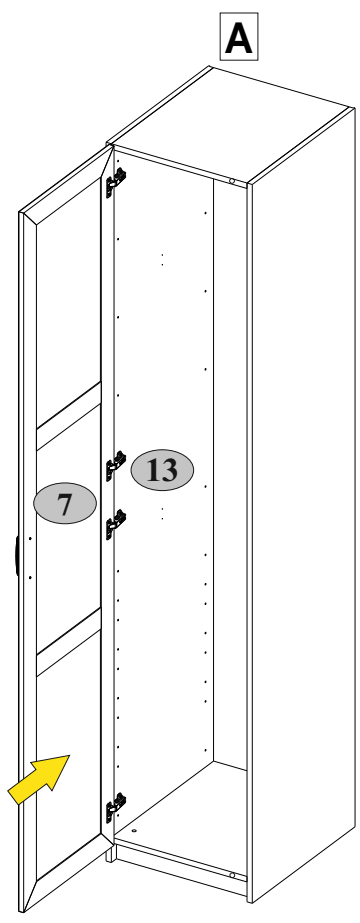

3

A

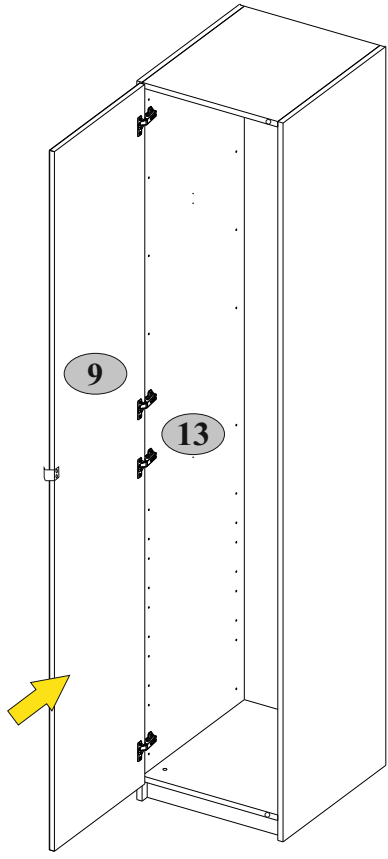

B

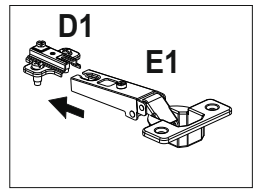
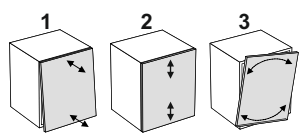
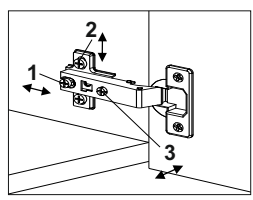
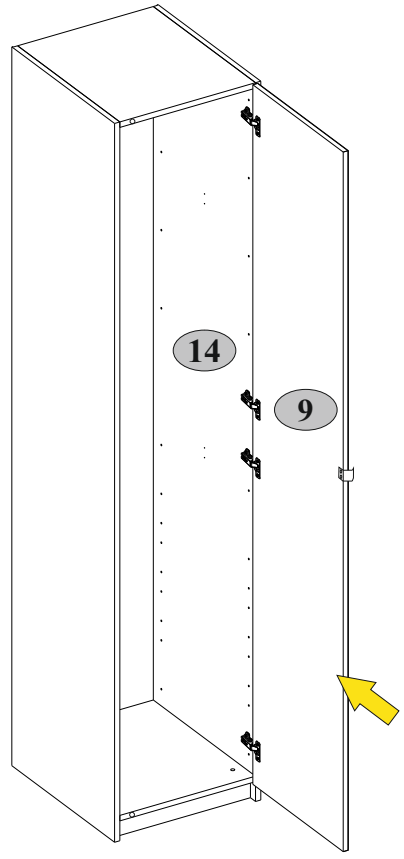

Накладка 56
Nakładka 56
Overlay 56

АН-056.30.00.00

№ п/п	Длина мм	Ширина мм	Толщина мм	Кол-во шт.	№ пачки
12	2355	584	16	1	1/1

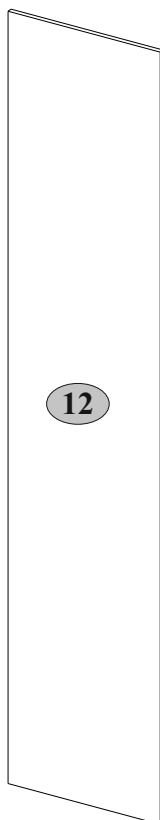
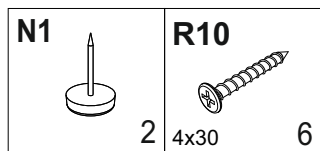

1

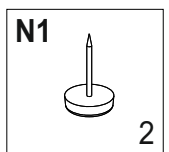

Накладка 56
Nakładka 56
Overlay 56

AH-056.30.00.00

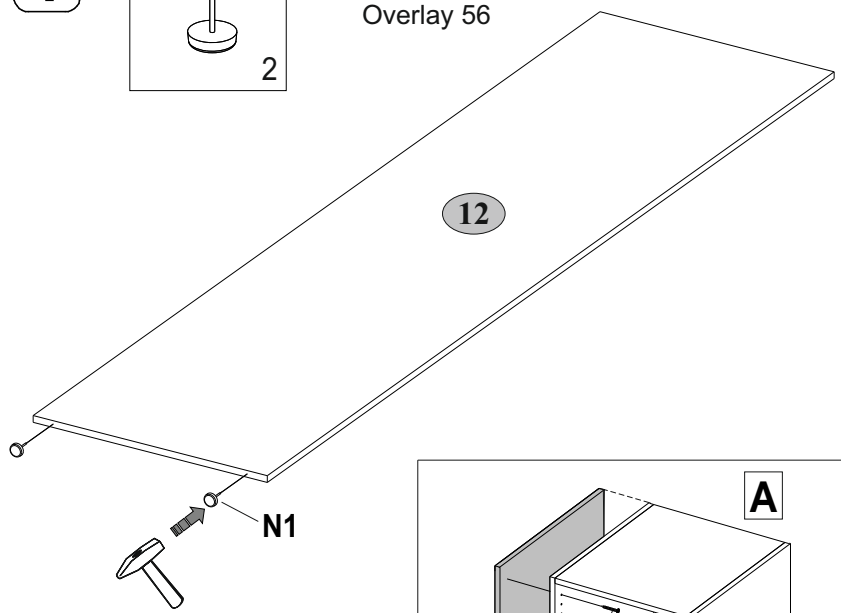

2

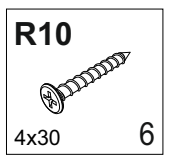



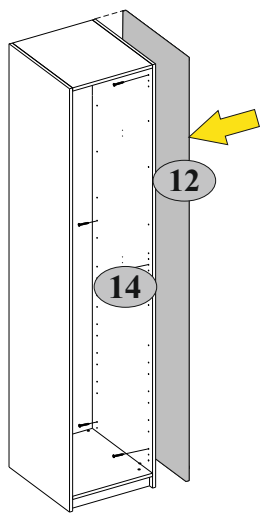

B

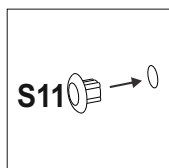
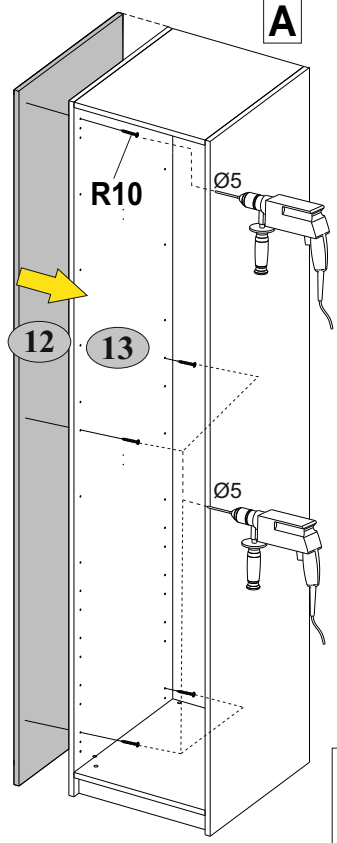

A



Штанга 50
Sztanga 50
Crossbar 50

R102  3,5x16	Y1  4	Y2  2	457  1
--	---	---	--

1

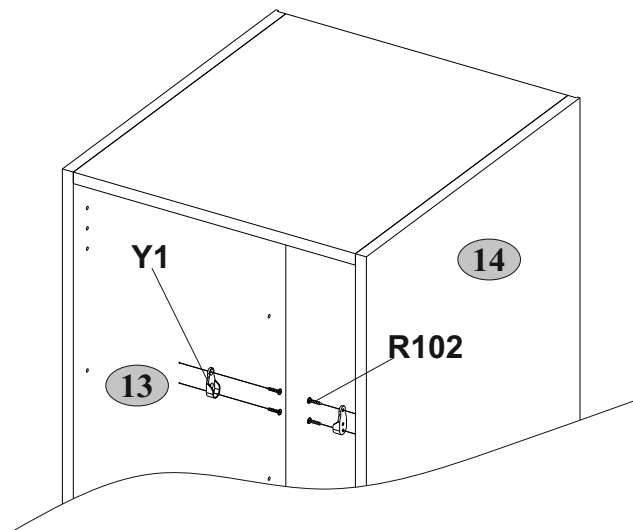

2

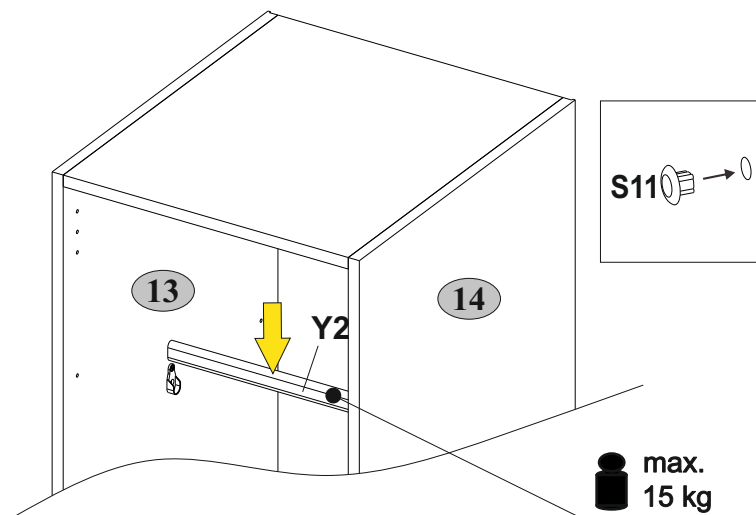

1

A3

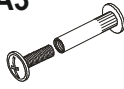

M4x30

4

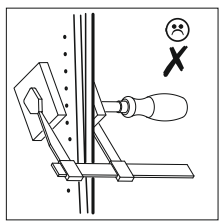
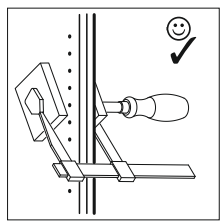
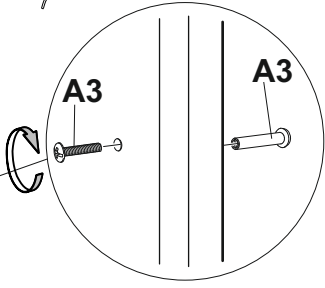
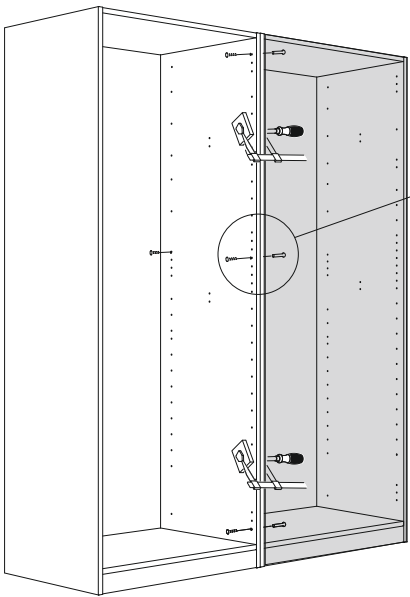
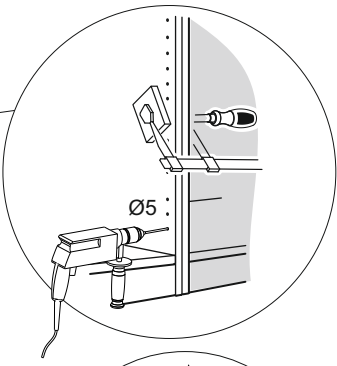
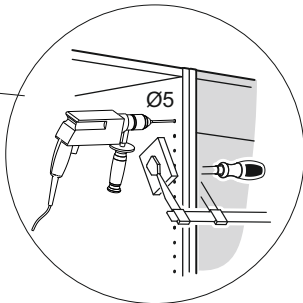
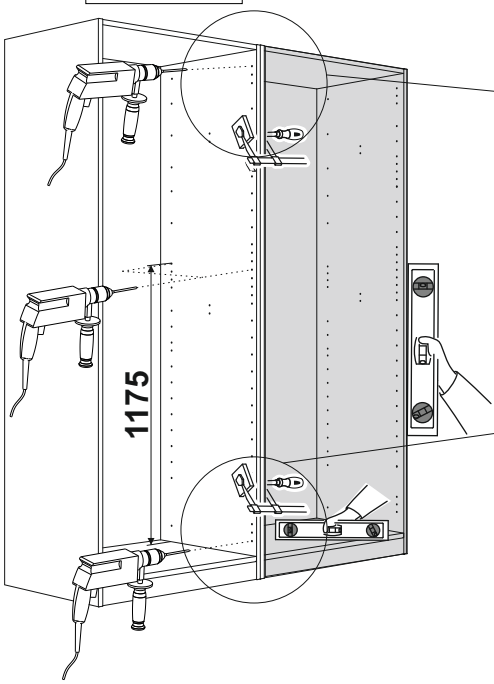

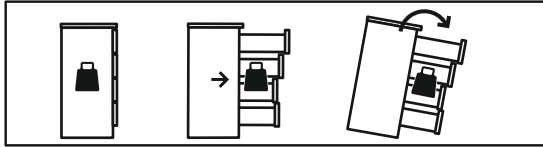

RU

ВНИМАНИЕ!

Опрокидывание мебели может стать причиной получения серьезных травм и привести к смерти.

Чтобы предотвратить опрокидывание, **ВСЕГДА** крепите мебель к стене с помощью фурнитуры, предотвращающей опрокидывание.

В целях принятия мер дополнительной безопасности для предотвращения опрокидывания:

- Храните тяжелые предметы в нижнем ящике.
- Не ставьте тяжелые предметы сверху.
- Никогда не позволяйте детям залезать на ящики, дверцы или полки, а также виснуть на них.
- Используйте мебель по своему прямому назначению.

PL

OSTRZEŻENIE!

Przewrócenie się mebla może spowodować poważne lub śmiertelne obrażenia ciała na skutek przygniecenia.

ZAWSZE przymocuj ten mebel do ściany za pomocą ograniczników.

Aby dodatkowo ograniczyć ryzyko poważnych obrażeń ciała i śmierci na skutek przewrócenia się mebla:

- Najcięższe przedmioty umieść w dolnej szufladzie.
- Nie kładź na wierzchu ciężkich przedmiotów.
- Nigdy nie pozwalaj dzieciom wspinać się na szuflady, drzwiczki lub półki.
- Używaj mebli zgodnie z ich przeznaczeniem.

EN

WARNING!

Serious or fatal crushing injuries can occur from furniture tip-over.

ALWAYS secure this furniture to the wall using tip-over restraints.

To further reduce the risk of serious injury and death from tip-overs:

- Place heaviest items in the lower drawer.
- Do not heave objects on top of this product.
- Never let children climb or hang on drawers, doors, or shelves.
- Use the furniture for its intended purpose.