

MDI. DT. MRB. 9

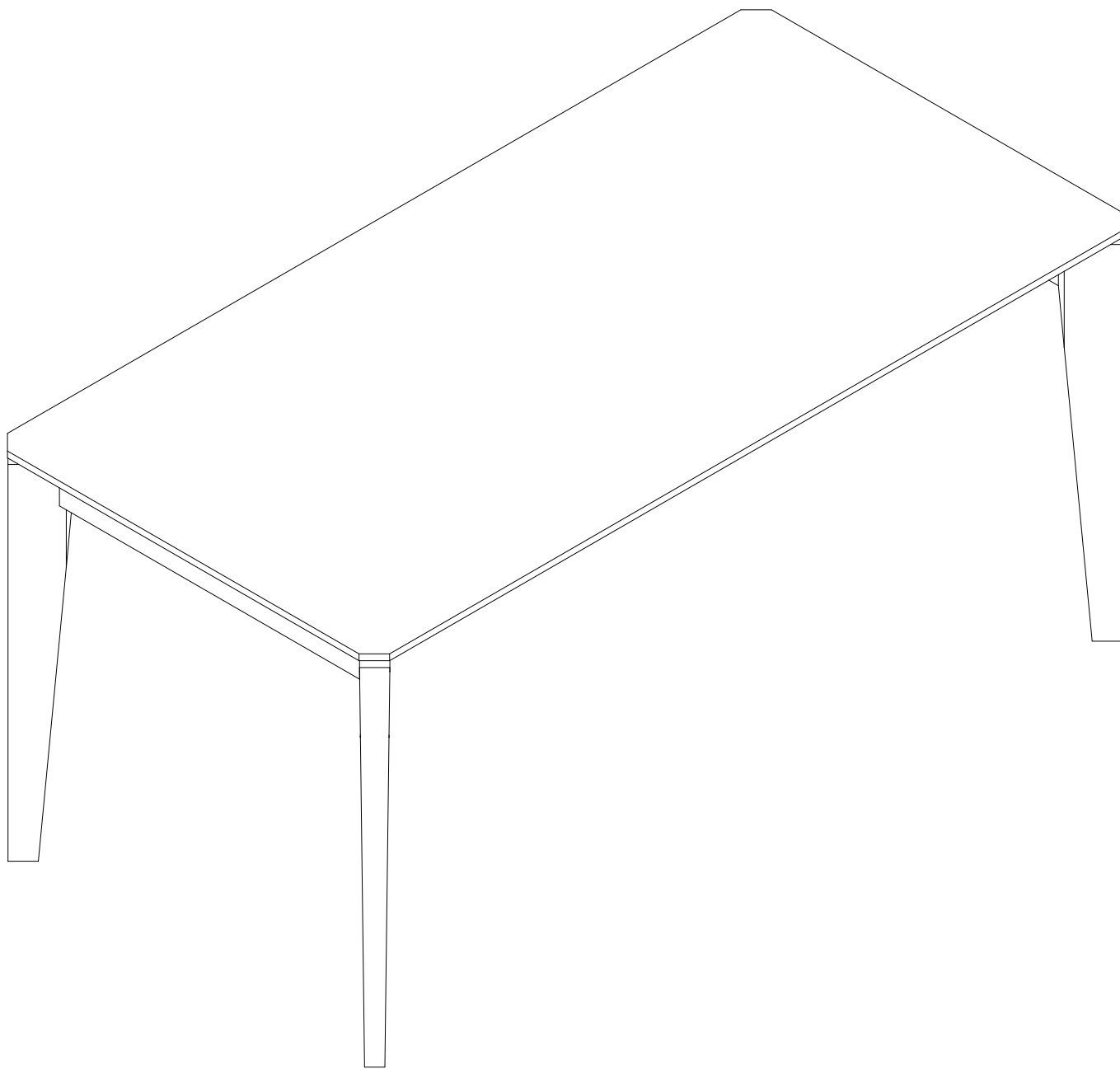

**EAC**

# MDI. DT. MRB. 9

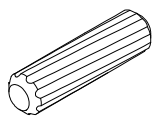
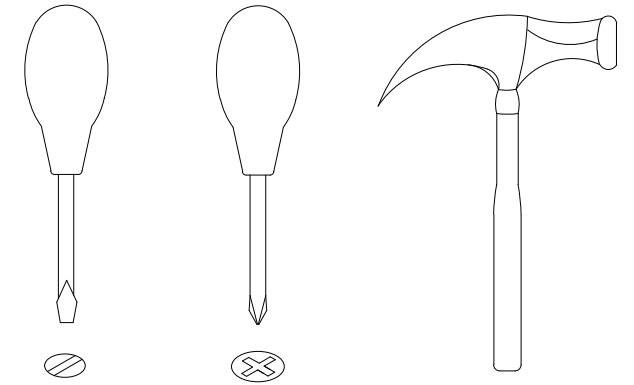
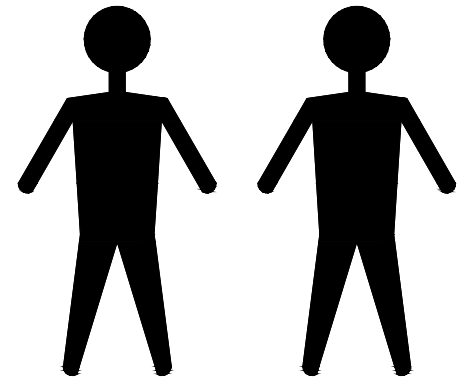

A x8  
Spec:  $\varnothing 8 * L30$

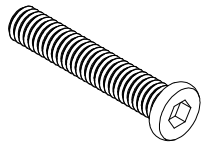

C x12  
Spec: 5/16\*45



D x12  
Spec:  $\varnothing 8 * \varnothing 14$

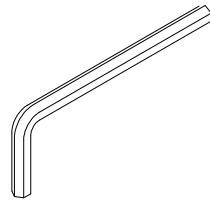

E x1  
Spec: 5#

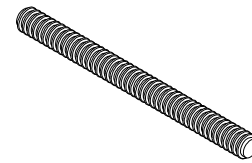

F x4  
Spec: M8\*L95

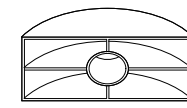

G x4  
Spec:

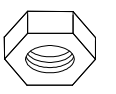

H x4  
Spec: M8

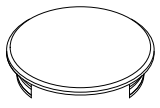

I x4  
Spec:  $\varnothing 38$

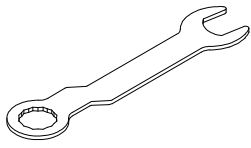

J x1  
Spec: 14#

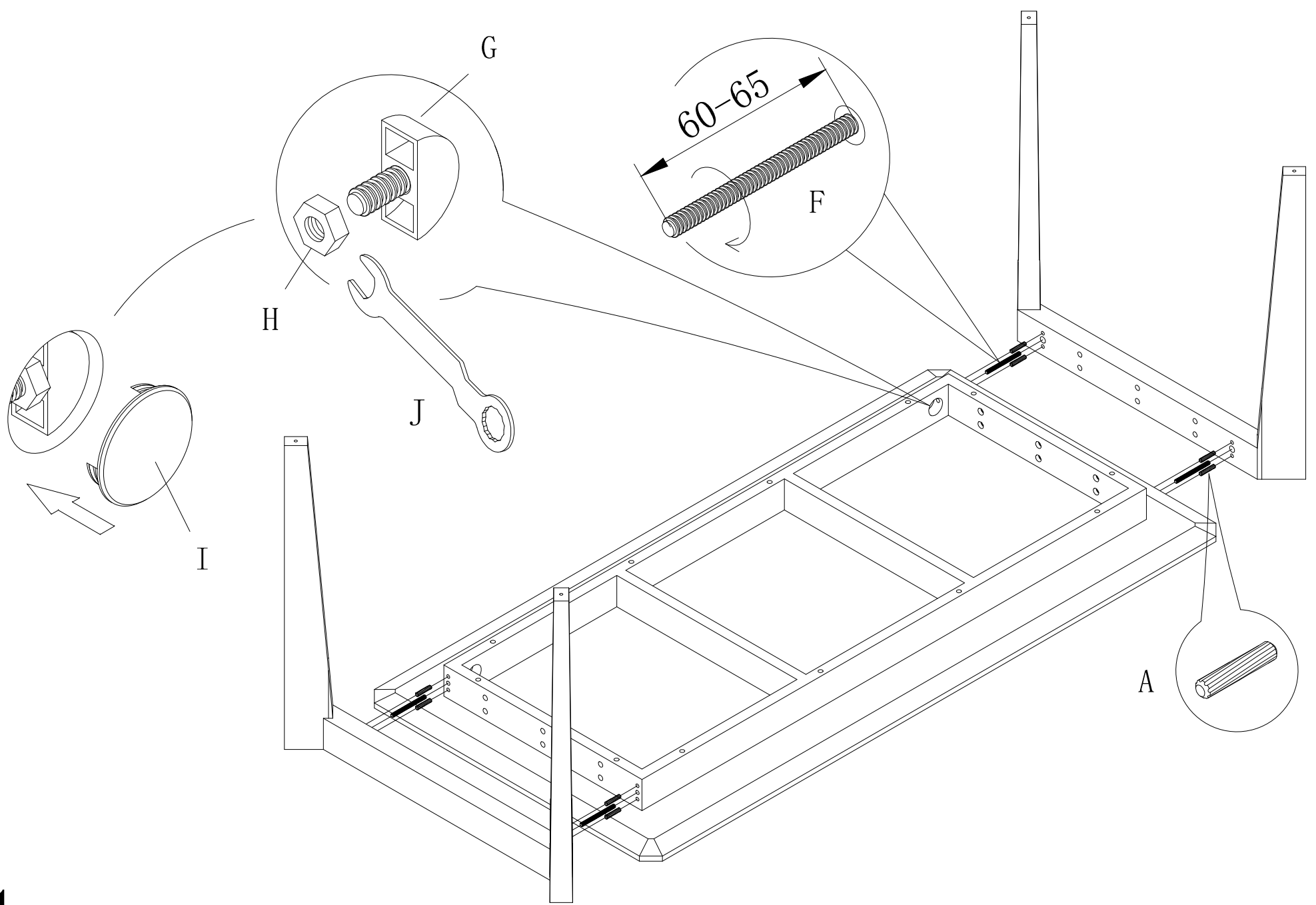

1

2

